

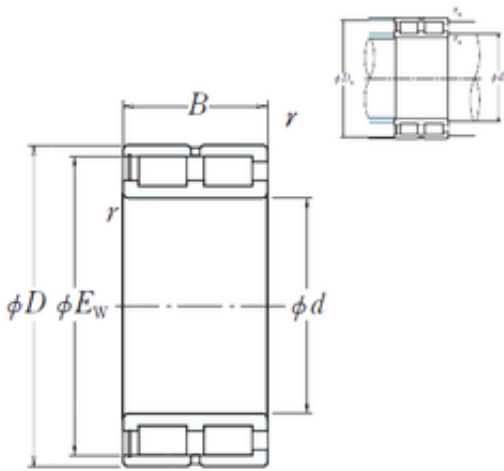

NNCF4938V NSK CYLINDRICAL ROLLER BEARING

Bearing No. NNCF4938V



NNCF4938V Bearing 2D drawings and 3D CAD models

Size	190x240.7x69 mm
Bore Diameter	190 mm
Outer Diameter	240,7 mm
Width	69 mm
d	190 mm
D	260 mm
Ew	240,7 mm
B	69 mm
C	69 mm
r min.	2 mm
Da	245 mm
ra max.	2 mm
da	203 mm
Weight	11,1 Kg
Basic dynamic load rating (C)	565 kN