

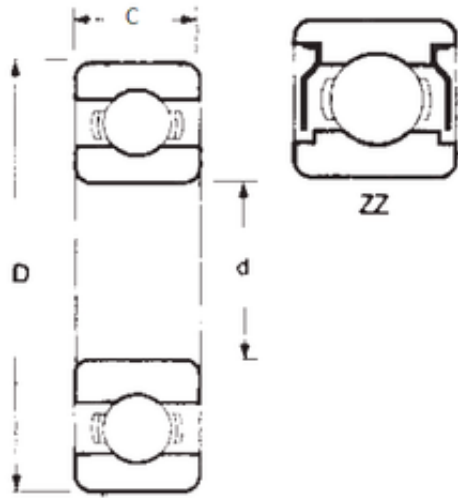

NTNY BEARING LTD



15 mm x 32 mm x 8 mm FBJ 16002ZZ deep groove ball bearings

Bearing No. 16002ZZ

Size	15x32x8 mm
Bore Diameter	15 mm
Outer Diameter	32 mm
Width	8 mm
d	15 mm
D	32 mm
B	8 mm
C	8 mm
Weight	0,025 Kg
Basic dynamic load rating (C)	5,59 kN
Basic static load rating (C0)	2,85 kN

16002ZZ Bearing 2D drawings and 3D CAD models